



PEAK (H50 - Ø70) design Aksu, Suardi



Tavolo basso

Anno di produzione: 2013

Versioni: luminosa, laccata.

Materiali: Polietilene, vetro temperato.

Dimensioni: Ø 70 h 50 cm

Peso: 10 Kg

Imballaggio: 71 x 71 x 52 cm

Volume imballaggio: 0,262 m³

Table bas

Année de production: 2013

Versions: lumineuse, laquée.

Matériaux: Polyéthylène, verre trempé.

Dimensions: Ø 70 h 50 cm

Poids: 10 Kg

Emballage: 71 x 71 x 52 cm

Volume emballage: 0,262 m³

Coffee table

Year of production: 2013

Versions: lighting, lacquered.

Material: Polyethylene, tempered glass.

Dimensions: Ø 70 h 50 cm

Weight: 10 Kg

Packaging: 71 x 71 x 52 cm

Packaging volume: 0,262 m³

DIMENSIONS (cm)			
CODE	LP PEA050		
LIGHTING	1x		Energy saving bulb recommended (not included).
COLOURS	LIGHTING COLOURS ○ LIGHT WHITE (code LA)	LACQUERED COLOURS ○ SIGNAL WHITE (code QA) ● JET BLACK (code QH) ● IRON GREY (code QG) ● FLAME RED (code QD) ● PURE ORANGE (code QC) ● ZINC YELLOW (code QB) ● LIME GREEN (code QR) ● MAGENTA (code QS) ● METALLIC SILVER (code QM) ● METALLIC GOLD (code QO)	



PEAK (H50 - Ø80) design Aksu, Suardi



Tavolo basso

Anno di produzione: 2013

Versioni: luminosa, laccata.

Materiali: Polietilene, vetro temperato.

Dimensioni: Ø 80 h 50 cm

Peso: 13 Kg

Imballaggio: 81 x 81 x 52 cm

Volume imballaggio: 0,341 m³

Table bas

Année de production: 2013

Versions: lumineuse, laquée.

Matériaux: Polyéthylène, verre trempé.

Dimensions: Ø 80 h 50 cm

Poids: 13 Kg

Emballage: 81 x 81 x 52 cm

Volume emballage: 0,341 m³

Coffee table

Year of production: 2013

Versions: lighting, lacquered.

Material: Polyethylene, tempered glass.

Dimensions: Ø 80 h 50 cm

Weight: 13 Kg

Packaging: 81 x 81 x 52 cm

Packaging volume: 0,341 m³

DIMENSIONS (cm)		
CODE	LP PEA051	
LIGHTING	1x	Energy saving bulb recommended (not included).
COLOURS	LIGHTING COLOURS ○ LIGHT WHITE (code LA)	LACQUERED COLOURS ○ SIGNAL WHITE (code QA) ● JET BLACK (code QH) ● IRON GREY (code QG) ● FLAME RED (code QD) ● PURE ORANGE (code QC) ● ZINC YELLOW (code QB) ● LIME GREEN (code QR) ● MAGENTA (code QS) ● METALLIC SILVER (code QM) ● METALLIC GOLD (code QO)



PEAK (H80 - Ø70) design Aksu, Suardi



Tavolo

Anno di produzione: 2010

Versioni: luminosa, laccata.

Materiali: Polietilene, vetro temperato.

Dimensioni: Ø 70 h 80 cm

Peso: 12 Kg

Imballaggio: 71 x 71 x 85 cm

Volume imballaggio: 0,556 m³

Table

Année de production: 2010

Versions: lumineuse, laquée.

Matériaux: Polyéthylène, verre trempé.

Dimensions: Ø 70 h 80 cm

Poids: 12 Kg

Emballage: 71 x 71 x 85 cm

Volume emballage: 0,556 m³

Table

Year of production: 2010

Versions: lighting, lacquered.

Material: Polyethylene, tempered glass.

Dimensions: Ø 70 h 80 cm

Weight: 12 Kg

Packaging: 71 x 71 x 85 cm

Packaging volume: 0,556 m³

DIMENSIONS (cm)			
CODE	LP PEA080		
LIGHTING	1x		1x Energy saving bulb recommended (not included).
COLOURS	LIGHTING COLOURS ○ LIGHT WHITE (code LA)	LACQUERED COLOURS ● SIGNAL WHITE (code QA) ● JET BLACK (code QH) ● IRON GREY (code QG) ● FLAME RED (code QD) ● PURE ORANGE (code QC) ● ZINC YELLOW (code QB) ● LIME GREEN (code QR) ● MAGENTA (code QS) ● METALLIC SILVER (code QM) ● METALLIC GOLD (code QO)	



PEAK (H80 - Ø80) design Aksu, Suardi



Tavolo

Anno di produzione: 2010

Versioni: luminosa, laccata.

Materiali: Polietilene, vetro temperato.

Dimensioni: Ø 80 h 80 cm

Peso: 15 Kg

Imballaggio: 81 x 81 x 85 cm

Volume imballaggio: 0,558 m³

Table

Année de production: 2010

Versions: lumineuse, laquée.

Matériaux: Polyéthylène, verre trempé.

Dimensions: Ø 80 h 80 cm

Poids: 15 Kg

Emballage: 81 x 81 x 85 cm

Volume emballage: 0,558 m³

Table

Year of production: 2010

Versions: lighting, lacquered.

Material: Polyethylene, tempered glass.

Dimensions: Ø 80 h 80 cm

Weight: 15 Kg

Packaging: 81 x 81 x 85 cm

Packaging volume: 0,558 m³

DIMENSIONS (cm)		
CODE	LP PEA081	
LIGHTING	1x	1x Energy saving bulb recommended (not included).
COLOURS	LIGHTING COLOURS ○ LIGHT WHITE (code LA)	LACQUERED COLOURS ● SIGNAL WHITE (code QA) ● JET BLACK (code QH) ● IRON GREY (code QG) ● FLAME RED (code QD) ● PURE ORANGE (code QC) ● ZINC YELLOW (code QB) ● LIME GREEN (code QR) ● MAGENTA (code QS) ● METALLIC SILVER (code QM) ● METALLIC GOLD (code QO)



PEAK (H120 - Ø70) design Aksu, Suardi



Tavolo alto
 Anno di produzione: 2010
 Versioni: luminosa, laccata.
 Materiali: Polietilene, vetro temperato.
 Dimensioni: Ø 70 h 120 cm
 Peso: 15 Kg
 Imballaggio: 71 x 71 x 125 cm
 Volume imballaggio: 0,63 m³

Table haut
 Année de production: 2010
 Versions: lumineuse, laquée.
 Matériaux: Polyéthylène, verre trempé.
 Dimensions: Ø 70 h 120 cm
 Poids: 15 Kg
 Emballage: 71 x 71 x 125 cm
 Volume emballage: 0,63 m³

High table
 Year of production: 2010
 Versions: lighting, lacquered.
 Material: Polyethylene, tempered glass.
 Dimensions: Ø 70 h 120 cm
 Weight: 15 Kg
 Packaging: 71 x 71 x 125 cm
 Packaging volume: 0,63 m³

DIMENSIONS (cm)		
CODE	LP PEA120	
LIGHTING	1x	Energy saving bulb recommended (not included).
COLOURS	LIGHTING COLOURS ○ LIGHT WHITE (code LA)	LACQUERED COLOURS ○ SIGNAL WHITE (code QA) ● JET BLACK (code QH) ● IRON GREY (code QG) ● FLAME RED (code QD) ● PURE ORANGE (code QC) ● ZINC YELLOW (code QB) ● LIME GREEN (code QR) ● MAGENTA (code QS) ● METALLIC SILVER (code QM) ● METALLIC GOLD (code QO)



PEAK (H120 - Ø80) design Aksu, Suardi



Tavolo alto
 Anno di produzione: 2010
 Versioni: luminosa, laccata.
 Materiali: Polietilene, vetro temperato.
 Dimensioni: Ø 80 h 120 cm
 Peso: 18 Kg
 Imballaggio: 81 x 81 x 125 cm
 Volume imballaggio: 0,82 m³

Table haut
 Année de production: 2010
 Versions: lumineuse, laquée.
 Matériaux: Polyéthylène, verre trempé.
 Dimensions: Ø 80 h 120 cm
 Poids: 18 Kg
 Emballage: 81 x 81 x 125 cm
 Volume emballage: 0,82 m³

High table
 Year of production: 2010
 Versions: lighting, lacquered.
 Material: Polyethylene, tempered glass.
 Dimensions: Ø 80 h 120 cm
 Weight: 18 Kg
 Packaging: 81 x 81 x 125 cm
 Packaging volume: 0,82 m³

DIMENSIONS (cm)		
CODE	LP PEA121	
LIGHTING	1x	1x Energy saving bulb recommended (not included).
COLOURS	LIGHTING COLOURS ○ LIGHT WHITE (code LA)	LACQUERED COLOURS ○ SIGNAL WHITE (code QA) ● JET BLACK (code QH) ● IRON GREY (code QG) ● FLAME RED (code QD) ● PURE ORANGE (code QC) ● ZINC YELLOW (code QB) ● LIME GREEN (code QR) ● MAGENTA (code QS) ● METALLIC SILVER (code QM) ● METALLIC GOLD (code QO)



PEAK (H50 - SQUARE GLASS) design Aksu, Suardi



Tavolo basso

Anno di produzione: 2013

Versioni: luminosa, laccata.

Materiali: Polietilene, vetro temperato.

Dimensioni: 80 x 80 h 50 cm

Peso: 21 Kg

Imballaggio: 81 x 81 x 52 cm

Volume imballaggio: 0,341 m³

Table bas

Année de production: 2013

Versions: lumineuse, laquée.

Matériaux: Polyéthylène, verre trempé.

Dimensions: 80 x 80 h 50 cm

Poids: 21 Kg

Emballage: 81 x 81 x 52 cm

Volume emballage: 0,341 m³

Coffee table

Year of production: 2013

Versions: lighting, lacquered.

Material: Polyethylene, tempered glass.

Dimensions: 80 x 80 h 50 cm

Weight: 21 Kg

Packaging: 81 x 81 x 52 cm

Packaging volume: 0,341 m³

DIMENSIONS (cm)		
CODE	LP PEA052	
LIGHTING	1x	Energy saving bulb recommended (not included).
COLOURS	LIGHTING COLOURS ○ LIGHT WHITE (code LA)	LACQUERED COLOURS ● SIGNAL WHITE (code QA) ● JET BLACK (code QH) ● IRON GREY (code QG) ● FLAME RED (code QD) ● PURE ORANGE (code QC) ● ZINC YELLOW (code QB) ● LIME GREEN (code QR) ● MAGENTA (code QS) ● METALLIC SILVER (code QM) ● METALLIC GOLD (code QO)



PEAK (H80 - SQUARE GLASS) design Aksu, Suardi



Tavolo

Anno di produzione: 2012

Versioni: luminosa, laccata.

Materiali: Polietilene, vetro temperato.

Dimensioni: 80 x 80 h 80 cm

Peso: 24 Kg

Imballaggio: 81 x 81 x 85 cm

Volume imballaggio: 0,558 m³

Table

Année de production: 2012

Versions: lumineuse, laquée.

Matériaux: Polyéthylène, verre trempé.

Dimensions: 80 x 80 h 80 cm

Poids: 24 Kg

Emballage: 81 x 81 x 85 cm

Volume emballage: 0,558 m³

Table

Year of production: 2012

Versions: lighting, lacquered.

Material: Polyethylene, tempered glass.

Dimensions: 80 x 80 h 80 cm

Weight: 24 Kg

Packaging: 81 x 81 x 85 cm

Packaging volume: 0,558 m³

DIMENSIONS (cm)		
CODE	LP PEA082	
LIGHTING	1x	Energy saving bulb recommended (not included).
COLOURS	LIGHTING COLOURS ○ LIGHT WHITE (code LA)	LACQUERED COLOURS ● SIGNAL WHITE (code QA) ● JET BLACK (code QH) ● IRON GREY (code QG) ● FLAME RED (code QD) ● PURE ORANGE (code QC) ● ZINC YELLOW (code QB) ● LIME GREEN (code QR) ● MAGENTA (code QS) ● METALLIC SILVER (code QM) ● METALLIC GOLD (code QO)



PEAK (H120 - SQUARE GLASS 80) design Aksu, Suardi



Tavolo alto

Anno di produzione: 2012

Versioni: luminosa, laccata.

Materiali: Polietilene, vetro temperato.

Dimensioni: 80 x 80 h 120 cm

Peso: 27 Kg

Imballaggio: 81 x 81 x 125 cm

Volume imballaggio: 0,82 m³

Table haut

Année de production: 2012

Versions: lumineuse, laquée.

Matériaux: Polyéthylène, verre trempé.

Dimensions: 80 x 80 h 120 cm

Poids: 27 Kg

Emballage: 81 x 81 x 125 cm

Volume emballage: 0,82 m³

High table

Year of production: 2012

Versions: lighting, lacquered.

Material: Polyethylene, tempered glass.

Dimensions: 80 x 80 h 120 cm

Weight: 27 Kg

Packaging: 81 x 81 x 125 cm

Packaging volume: 0,82 m³

DIMENSIONS (cm)		
CODE	LP PEA122	
LIGHTING	1x	Energy saving bulb recommended (not included).
COLOURS	LIGHTING COLOURS ○ LIGHT WHITE (code LA)	LACQUERED COLOURS ● SIGNAL WHITE (code QA) ● JET BLACK (code QH) ● IRON GREY (code QG) ● FLAME RED (code QD) ● PURE ORANGE (code QC) ● ZINC YELLOW (code QB) ● LIME GREEN (code QR) ● MAGENTA (code QS) ● METALLIC SILVER (code QM) ● METALLIC GOLD (code QO)



PEAK (H80 - DOUBLE) design Aksu, Suardi



Tavolo

Anno di produzione: 2012

Versioni: luminosa, laccata.

Materiali: Polietilene, vetro temperato.

Dimensioni: 180 x 80 h 80 cm

Peso: 52 Kg

Imballaggio: 181 x 81 x 50 cm

Volume imballaggio: 0,733 m³

Table

Année de production: 2012

Versions: lumineuse, laquée.

Matériaux: Polyéthylène, verre trempé.

Dimensions: 180 x 80 h 80 cm

Poids: 52 Kg

Emballage: 181 x 81 x 50 cm

Volume emballage: 0,733 m³

Table

Year of production: 2012

Versions: lighting, lacquered.

Material: Polyethylene, tempered glass.

Dimensions: 180 x 80 h 80 cm

Weight: 52 Kg

Packaging: 181 x 81 x 50 cm

Packaging volume: 0,733 m³

DIMENSIONS (cm)		
CODE	LP PEA220	
LIGHTING	2x	Energy saving bulb recommended (not included).
COLOURS	LIGHTING COLOURS ○ LIGHT WHITE (code LA)	LACQUERED COLOURS ○ SIGNAL WHITE (code QA) ● JET BLACK (code QH) ● IRON GREY (code QG) ● FLAME RED (code QD) ● PURE ORANGE (code QC) ● ZINC YELLOW (code QB) ● LIME GREEN (code QR) ● MAGENTA (code QS) ● METALLIC SILVER (code QM) ● METALLIC GOLD (code QO)



PEAK (H120 - DOUBLE) design Aksu, Suardi



Tavolo alto
 Anno di produzione: 2012
 Versioni: luminosa, laccata.
 Materiali: Polietilene, vetro temperato.
 Dimensioni: 180 x 80 h 120 cm
 Peso: 58 Kg
 Imballaggio: 181 x 111 x 50 cm
 Volume imballaggio: 1 m³

Table haut
 Année de production: 2012
 Versions: lumineuse, laquée.
 Matériaux: Polyéthylène, verre trempé.
 Dimensions: 180 x 80 h 120 cm
 Poids: 58 Kg
 Emballage: 181 x 111 x 50 cm
 Volume emballage: 1 m³

High table
 Year of production: 2012
 Versions: lighting, lacquered.
 Material: Polyethylene, tempered glass.
 Dimensions: 180 x 80 h 120 cm
 Weight: 58 Kg
 Packaging: 181 x 111 x 50 cm
 Packaging volume: 1 m³

DIMENSIONS (cm)				
CODE	LP PEA221			
LIGHTING	2x	Energy saving bulb recommended (not included).		
COLOURS	<table border="0"> <tr> <td style="vertical-align: top;"> LIGHTING COLOURS <ul style="list-style-type: none"> ○ LIGHT WHITE (code LA) </td> <td style="vertical-align: top;"> LACQUERED COLOURS <ul style="list-style-type: none"> ○ SIGNAL WHITE (code QA) ● JET BLACK (code QH) ● IRON GREY (code QG) ● FLAME RED (code QD) ● PURE ORANGE (code QC) ● ZINC YELLOW (code QB) ● LIME GREEN (code QR) ● MAGENTA (code QS) ● METALLIC SILVER (code QM) ● METALLIC GOLD (code QO) </td> </tr> </table>		LIGHTING COLOURS <ul style="list-style-type: none"> ○ LIGHT WHITE (code LA) 	LACQUERED COLOURS <ul style="list-style-type: none"> ○ SIGNAL WHITE (code QA) ● JET BLACK (code QH) ● IRON GREY (code QG) ● FLAME RED (code QD) ● PURE ORANGE (code QC) ● ZINC YELLOW (code QB) ● LIME GREEN (code QR) ● MAGENTA (code QS) ● METALLIC SILVER (code QM) ● METALLIC GOLD (code QO)
LIGHTING COLOURS <ul style="list-style-type: none"> ○ LIGHT WHITE (code LA) 	LACQUERED COLOURS <ul style="list-style-type: none"> ○ SIGNAL WHITE (code QA) ● JET BLACK (code QH) ● IRON GREY (code QG) ● FLAME RED (code QD) ● PURE ORANGE (code QC) ● ZINC YELLOW (code QB) ● LIME GREEN (code QR) ● MAGENTA (code QS) ● METALLIC SILVER (code QM) ● METALLIC GOLD (code QO) 			



PEAK ACCESSORIES



DIMENSIONS (cm) - CODE - COLOURS

ICE BUCKET

Material: polypropylene (PP).
Dimensions: Ø 20 h 23 cm

LP BAR116

COLOURS TRANSPARENT
 SMOKED GREY

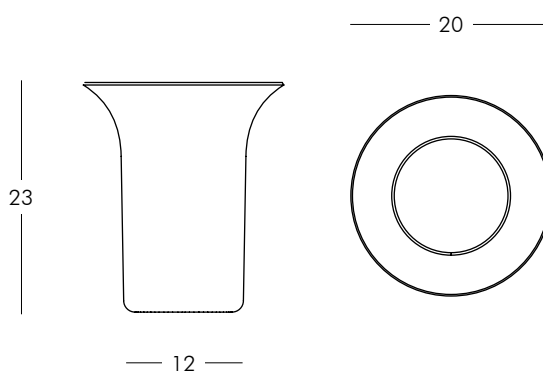

ASHTRAY

Material: metal.
Dimensions: Ø 16 h 3,5 cm

SD PEA002

COLOURS WHITE

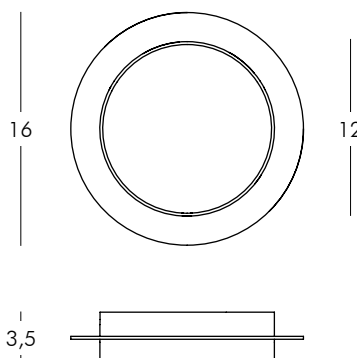
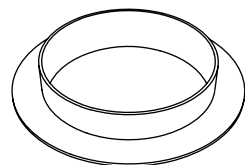

BAG HOOK







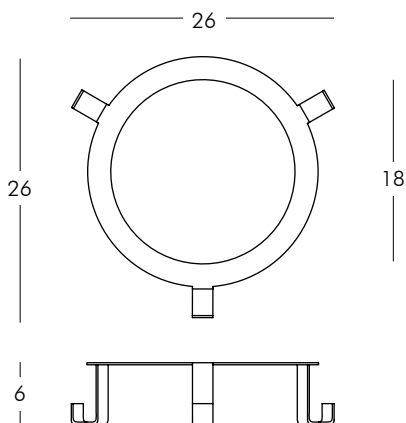
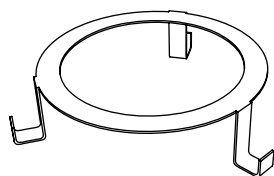







Material: metal.
Dimensions: 26 x 26 h 6 cm

SD PEA003













COLOURS WHITE





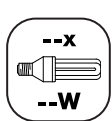

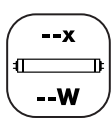
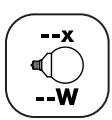
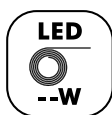





SYMBOLS

 For indoor use.	 Insulation class 1.	 Protected against the intrusion of solid objects $\varnothing > 12$ mm, not against water.
 For indoor and outdoor use.	 Insulation class 2.	 Protected against the intrusion of solid objects $\varnothing > 1$ mm and splashing water.
 Stackable item.	 Insulation class 3.	 Protected against the intrusion of dust and water jets.
 Conformity to the European Community instructions.	 Device proper to direct assembly onto normally inflammable surfaces.	 Fully protected against the intrusion of dust and immersion in water.
 European Community registered model.	 100% recyclable polyethylene.	 Recycling and disposal of electronic waste (WEEE).

LIGHTING SYMBOLS

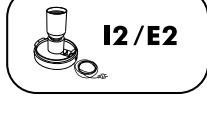
 Small lamp base for E14 - 14 mm light bulb.	 Lamp base for G13 neon tube.	 LED technology lighting system.
 Medium lamp base for E26 - 26 mm light bulb.	 Lamp base for GU10 spotlight.	 Neon tube lighting system.
 Standard lamp base for E27 - 27 mm light bulb.	 Lamp base for G4 halogen bulb.	
 Lighting through energy saving bulb. The upper figure shows the number of allowed bulbs. The lower figure shows the MAXIMUM recommended power.	 Lighting through energy saving fluorescent spotlight. The upper figure shows the number of allowed spotlights. The lower figure shows the MAXIMUM recommended power.	
 Lighting through neon tube. The upper figure shows the number of allowed neon tubes. The lower figure shows the MAXIMUM recommended power.	 Lighting through energy saving globe bulb. The upper figure shows the number of allowed bulbs. The lower figure shows the MAXIMUM recommended power.	
 Lighting through flexible LED tube. The lower figure shows the MAXIMUM recommended power.	 Lighting through circular T9 neon tube. The upper figure shows the number of allowed neon tubes. The lower figure shows the MAXIMUM recommended power.	

WIRING SYMBOLS

 Wiring with metal clamp. IP20 protection. Diameter 11 cm.	 Wiring with special base for KIT LED 1,5 WATT. IP55 protection. Diameter 11,6 cm.
 Wiring with metal base. IP55 protection. Diameter 10 cm. Fastening by hex screw key.	 Wiring with plastic screw base. I3 - IP20 protection. E3 - IP55 protection. Diameter 6 cm.
 Wiring with metal base. IP55 protection. Diameter 20 cm. Fastening by hex screw key.	 Wiring with plastic screw base. I3 - IP20 protection. E3 - IP55 protection. Diameter 10 cm.
 Wiring with plastic base and metal inserts. I2 - IP20 protection. E2 - IP55 protection. Diameter 10 cm. Fastening by slot screwdriver.	 Wiring with plastic screw base. I3 - IP20 protection. E3 - IP55 protection. Diameter 15 cm.
 Wiring with plastic base for LED LP RGB100. IP44 protection. Diameter 10 cm.	 Special metal base. IP20 protection. Several sizes.

MATERIAL PROPERTIES

Material: Linear low-density polyethylene - LLDPE.

Production process: rotational moulding.

Resistant to extreme temperatures (-60°C to +80°C).

UV resistant (except for lighting colours).

High tensile strength.

WARNING

- Keep away from excessive heat sources.
- Avoid any improper use. Do not stand on the products. When the product has to be moved, lift the product off the ground in order to avoid damage.
- Do not overload the pot structure in order to avoid deforming.
- Carefully comply with the maintenance & cleaning instructions.
- In case of malfunctioning or damage of the wiring or any electrical parts, refer to a qualified electrician.

MAINTENANCE & CLEANING

- To prevent dust and dirt from sticking to the plastic surfaces, periodically clean the products with a damp cloth and neutral liquid soap diluted in water.
- Avoid using ethanol or any liquids containing, even in small amounts, acetone, trichloroethylene or ammonia (solvents in general).
- It is recommended the use of SLIDE's "CleanUp" cleaner or a degreaser. In case of persistent stains, use a scrub eraser (melamine foam - Scotch-Brite® Easy Eraser or similar) or a high pressure washer. Spray the cleaning product on the surface, rub with a damp cloth and rinse abundantly with water (preferably with a high pressure washer).
- The lacquered version is suitable also for outdoor use, however it is more sensitive to scratches: periodically clean with a polish cleaner, gently rubbing with soft cloth/cotton wool.
- Cushions can be cleaned with a damp cloth, neutral liquid soap and water.
- For metal parts use specific cleaners.

SUSTAINABILITY & RECYCLING

All SLIDE products are 100% recyclable. Furthermore, grey, black and chocolate matt colours are produced with recycled polyethylene. SLIDE has a closed production cycle with no health prejudicial emissions and complying with ecological sustainability rules.

When a product reaches the end of its life, do not treat the product or any of its parts as domestic waste. Dispose by sending to differentiated collection centres.

RESPONSIBILITY & RETURNS

SLIDE declines any liability to damages caused to things or persons by an illegitimate use of the product. SLIDE won't accept any returned goods without having checked the kind of defects first.















WARRANTY

SLIDE products are guaranteed against all manufacturing faults, granted that the items are appropriately used, for twenty-four (24) months from the date of purchase upon presentation of the invoice.















LED KITS only are guaranteed for twelve (12) months from the date of purchase.

Warranty doesn't include parts that are subject to wear and tear due to usage, batteries when provided, wiring and electrical parts that do not have manufacturing faults.



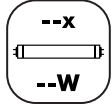

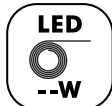





SYMBOLS

 For indoor use.	 Insulation class 1.	 Protected against the intrusion of solid objects $\varnothing > 12$ mm, not against water.
 For indoor and outdoor use.	 Insulation class 2.	 Protected against the intrusion of solid objects $\varnothing > 1$ mm and splashing water.
 Stackable item.	 Insulation class 3.	 Protected against the intrusion of dust and water jets.
 Conformity to the European Community instructions.	 Device proper to direct assembly onto normally inflammable surfaces.	 Fully protected against the intrusion of dust and immersion in water.
 European Community registered model.	 100% recyclable polyethylene.	 Recycling and disposal of electronic waste (WEEE).

LIGHTING SYMBOLS

 Small lamp base for E14 - 14 mm light bulb.	 Lamp base for G13 neon tube.	 LED technology lighting system.
 Medium lamp base for E26 - 26 mm light bulb.	 Lamp base for GU10 spotlight.	 Neon tube lighting system.
 Standard lamp base for E27 - 27 mm light bulb.	 Lamp base for G4 halogen bulb.	
 --X Lighting through energy saving bulb. The upper figure shows the number of allowed bulbs. --W The lower figure shows the MAXIMUM recommended power.	 --X Lighting through energy saving fluorescent spotlight. The upper figure shows the number of allowed spotlights. --W The lower figure shows the MAXIMUM recommended power.	
 --X Lighting through neon tube. The upper figure shows the number of allowed neon tubes. --W The lower figure shows the MAXIMUM recommended power.	 --X Lighting through energy saving globe bulb. The upper figure shows the number of allowed bulbs. --W The lower figure shows the MAXIMUM recommended power.	
 LED Lighting through flexible LED tube. The lower figure shows the MAXIMUM recommended power.	 -xT9 Lighting through circular T9 neon tube. The upper figure shows the number of allowed neon tubes. --W The lower figure shows the MAXIMUM recommended power.	

WIRING SYMBOLS

 I1 Wiring with metal clamp. IP20 protection. Diameter 11 cm.	 LED 1,5W Wiring with special base for KIT LED 1,5 WATT. IP55 protection. Diameter 11,6 cm.
 E1 SMALL Wiring with metal base. IP55 protection. Diameter 10 cm. Fastening by hex screw key.	 E3/I3 SMALL Wiring with plastic screw base. I3 - IP20 protection. E3 - IP55 protection. Diameter 6 cm.
 E1 LARGE Wiring with metal base. IP55 protection. Diameter 20 cm. Fastening by hex screw key.	 E3/I3 MEDIUM Wiring with plastic screw base. I3 - IP20 protection. E3 - IP55 protection. Diameter 10 cm.
 I2/E2 Wiring with plastic base and metal inserts. I2 - IP20 protection. E2 - IP55 protection. Diameter 10 cm. Fastening by slot screwdriver.	 E3/I3 LARGE Wiring with plastic screw base. I3 - IP20 protection. E3 - IP55 protection. Diameter 15 cm.
 CANDY LIGHT LED 10W Wiring with plastic base for LED LP RGB100. IP44 protection. Diameter 10 cm.	 CUSTOM BASE Special metal base. IP20 protection. Several sizes.

MATERIAL PROPERTIES

Material: Linear low-density polyethylene - LLDPE.

Production process: rotational moulding.

Resistant to extreme temperatures (-60°C to +80°C).

UV resistant (except for lighting colours).

High tensile strength.

WARNING

- Keep away from excessive heat sources.
- Avoid any improper use. Do not stand on the products. When the product has to be moved, lift the product off the ground in order to avoid damage.
- Do not overload the pot structure in order to avoid deforming.
- Carefully comply with the maintenance & cleaning instructions.
- In case of malfunctioning or damage of the wiring or any electrical parts, refer to a qualified electrician.

MAINTENANCE & CLEANING

- To prevent dust and dirt from sticking to the plastic surfaces, periodically clean the products with a damp cloth and neutral liquid soap diluted in water.
- Avoid using ethanol or any liquids containing, even in small amounts, acetone, trichloroethylene or ammonia (solvents in general).
- It is recommended the use of SLIDE's "CleanUp" cleaner or a degreaser. In case of persistent stains, use a scrub eraser (melamine foam - Scotch-Brite® Easy Eraser or similar) or a high pressure washer. Spray the cleaning product on the surface, rub with a damp cloth and rinse abundantly with water (preferably with a high pressure washer).
- The lacquered version is suitable also for outdoor use, however it is more sensitive to scratches: periodically clean with a polish cleaner, gently rubbing with soft cloth/cotton wool.
- Cushions can be cleaned with a damp cloth, neutral liquid soap and water.
- For metal parts use specific cleaners.

SUSTAINABILITY & RECYCLING

All SLIDE products are 100% recyclable. Furthermore, grey, black and chocolate matt colours are produced with recycled polyethylene. SLIDE has a closed production cycle with no health prejudicial emissions and complying with ecological sustainability rules.

When a product reaches the end of its life, do not treat the product or any of its parts as domestic waste. Dispose by sending to differentiated collection centres.

RESPONSIBILITY & RETURNS

SLIDE declines any liability to damages caused to things or persons by an illegitimate use of the product. SLIDE won't accept any returned goods without having checked the kind of defects first.

WARRANTY

SLIDE products are guaranteed against all manufacturing faults, granted that the items are appropriately used, for twenty-four (24) months from the date of purchase upon presentation of the invoice.

LED KITS only are guaranteed for twelve (12) months from the date of purchase.

Warranty doesn't include parts that are subject to wear and tear due to usage, batteries when provided, wiring and electrical parts that do not have manufacturing faults.